

XMS-OSC Standalone Oscillation Controller

© 2009 Advanced Manufacturing Engineering Technologies
35 North 1st East, Rexburg, ID 83445
208-356-7274

Table of Contents

1.	Foreword.....	1-1
2.	General Safety.....	2-1
3.	XMS-OSC Standalone System General Description.....	3-1
3.1.	XMS-OSC Standalone System Features.....	3-1
3.1.1.	Applications	3-2
3.1.2.	General Specifications	3-2
3.2.	XMS Standalone System Major Components	3-2
3.2.1.	Emergency Stop (E-Stop)	3-2
3.2.2.	Sequence Buttons.....	3-3
3.2.3.	Soft Buttons	3-3
3.2.4.	Adjustment Knob	3-3
3.2.5.	Joystick	3-3
3.2.6.	Flash Memory Port	3-4
3.2.7.	LCD Display	3-4
4.	Installation.....	4-1
4.1.	Physical Description	4-1
4.2.	Power Requirements	4-1
4.3.	Environmental Considerations.....	4-1
4.4.	Connections.....	4-2
5.	Operation.....	5-1
5.1.	Initial Setup.....	5-1
5.2.	STARTUP Mode	5-1
5.2.1.	Downloading Firmware	5-2
5.2.2.	How to Load a Program.....	5-2
5.2.3.	How to Start a Program.....	5-2
5.2.4.	Error Messages.....	5-2
5.2.5.	How to Stop a Program.....	5-3





5.3.	SETUP Mode	5-3
5.4.	EDIT Mode	5-5
5.4.1.	How to Load a Program.....	5-6
5.4.2.	How to Create a Weld Program.....	5-6
5.4.3.	How to Save a Weld Program.....	5-7
5.5.	Power Down and Securing the Equipment.....	5-7
6.	General Maintenance	6-1
7.	Troubleshooting	7-1

1. Foreword

Welcome to the AMET Inc. family of automated welding products. AMET Inc. systems are designed to meet the most demanding applications. The XMS Standalone System automation allows precision digital control of Weld Current, Voltage, Wire Feed, and Travel Speed for any type of arc welding process application, large or small. This manual is intended to provide users of the AMET XMS Standalone Systems with general information on the setup, operation, and care of their systems.

Important Information About This Manual

Throughout this manual, these icons will highlight specific information related to each category.

<i>Icon</i>	<i>Function</i>
 Caution:	Caution - Highlight items, which can cause damage to the system and/or injury to operators.
 Note:	Note - Highlights or review important information and general points of interest.
 Tip:	Tip - Identifies programming suggestions and operational information for the XMS System.
	Safety - Identifies specific safety concerns. These items may vary depending on how the system is equipped; however, general safety practices remain constant in all situations and environments.

Customer Service Assistance

If you are experiencing difficulty with your system or for specific technical issues or questions concerning the setup, operation, calibration or maintenance of the XMS Standalone Systems, please contact AMET Technical Support at 208-356-7274.

2. General Safety

Arc Welding Safety Precautions



Arc Welding May Be **HAZARDOUS**.

PROTECT YOURSELF and others from possible serious injury or death!

KEEP CHILDREN AWAY at all times!

PACEMAKER WEARERS KEEP AWAY until such time as you have consulted your doctor.



Welding exposes you to certain hazards. However, welding is safe when precautions are taken. The following safety information only summarizes the more complete safety information found in the Principal Safety Standards manuals listed at the end of this section (p. 6).

Read and follow all Safety Standards!

ELECTRIC SHOCK CAN KILL

Touching live electrical parts may cause fatal shocks or severe burns. The electrode and work circuit are electrically live whenever the output is on. The input power circuit and machine internal circuits are also live when power is on. In automatic wire welding, the wire, wire reel, drive roll housing, and all metal parts touching the welding wire and torch are electrically live. Incorrectly installed or improperly grounded equipment is a hazard.



1. Do not touch live electrical parts.
2. Wear dry, hole-free insulating gloves and body protection.
3. Use dry insulating mats or covers to insulate yourself from work and ground.
4. Disconnect input power before installing or servicing the equipment.
5. Properly install and ground any equipment according to its Owner's Manual and national, state, and local codes.
6. Turn off all equipment when not in use.
7. Ground the work piece to a good electrical (earth) ground.
8. Do not touch electrodes while you are in contact with the work (ground) circuit.
9. Use only well maintained equipment. Repair or replace damaged parts at once.
10. Keep all panels and covers securely in place.

**ARC RAYS CAN BURN EYES AND SKIN
NOISE MAY DAMAGE HEARING**

Arc rays from the welding process produce intense heat and strong ultraviolet rays that will burn eyes and skin. Noise from some processes can damage hearing.



1. Wear a welding helmet fitted with a proper shade of filter (see ANSI Z49.1 listed in the Safety Standards) to protect your face and eyes when welding or watching.
2. Wear approved safety glasses. Face shields are recommended.
3. Use protective screens or barriers to protect others from flash and glare; warn others not to watch the arc.
4. Wear protective clothing made from durable, flame-resistant material (wool and leather) and foot protection.
5. Use approved earplugs or earmuffs if the noise level is high.

**FUMES AND GASES CAN BE HAZARDOUS TO
YOUR HEALTH**

Welding produces fumes and gases. Breathing these fumes and gases can be hazardous to your health.



1. Keep your head out of the fumes. Do not breathe fumes.
2. If indoors, ventilate the area and/or exhaust welding fumes and gases from the arc.
3. If ventilation is poor, use an approved air-supplied respirator.
4. Read the Material Safety Data Sheet (MSDS) and the manufacturer's instructions for metals, consumables, coatings, and cleaners.
5. Work in a confined space only if it is well ventilated, or while wearing an air-supplied respirator. Shielding gases used for welding can displace air, causing injury or death. Be sure the breathing air is safe.
6. Do not weld in locations near degreasing, cleaning, or spraying operations. The heat and rays of the arc can react with vapors to form highly toxic and irritating gases.
7. Do not weld on coated metals (such as galvanized, lead, or cadmium plated steel) unless the coating is removed from the weld area, the area is well ventilated, and if necessary, while wearing an air-supplied respirator. The coating and any metals containing these elements can give off toxic fumes if welded.

**FLYING SPARKS AND HOT METAL CAN
CAUSE INJURY**

Chipping and grinding cause flying metal. As welds cool, they can throw slag.



1. Wear approved face shields or safety goggles. Side shields are recommended.
2. Wear proper body protection to protect skin.

WELDING CAN CAUSE FIRE OR EXPLOSION

Sparks and spatter fly off from the welding arc. The flying sparks and hot metal, weld spatter, hot work piece, and hot equipment can cause fires and burns. Accidental contact of electrode or welding wire to metal objects can cause sparks, overheating, or fire.



1. Protect yourself and others from flying sparks and hot metals.
2. Do not weld where flying sparks can strike flammable material.
3. Remove all flammables within a minimum of 35 ft. (10.7m) of the welding arc. If this is not possible, tightly cover them with approved covers.
4. Be alert that welding sparks and hot materials from welding can easily go through small cracks and openings to adjacent areas.
5. Watch for fire and keep a fire extinguisher nearby.
6. Be aware that welding on a ceiling, floor, bulkhead, or partition can cause fire on the hidden side.
7. Welding sealed containers such as tanks or drums is very dangerous. Expanding gases within the container can cause explosions.
8. Connect work cable to the work as close to the welding area as practical to prevent welding current from traveling long, possibly unknown paths and causing electric shock and fire hazards.
9. Remove stick electrode from holder or cut off welding wire contact tip when not in use.
10. Wear oil-free protective garments such as leather gloves, heavy shirt, cuff-less trousers, high shoes, and a cap.

CYLINDERS CAN EXPLODE IF DAMAGED

Shielding gas cylinders contain gas under high pressure. If damaged, a cylinder can explode. Since gas cylinders are normally part of the welding process, be sure to treat them carefully.



1. Protect compressed gas cylinders from excessive heat, mechanical shocks, and arcs.
2. Install and secure cylinders in an upright position by chaining them to a stationary support or equipment cylinder rack to prevent falling or tipping.
3. Keep cylinders away from any welding or other electrical circuits.
4. Never allow a welding electrode to touch any cylinder.
5. Use only correct shielding gas cylinders, regulators, hoses, and fittings designed for the specific application; maintain them and associated parts in good condition.
6. Turn face away from valve outlet when opening cylinder valve.
7. Keep protective cap in place over valve except when cylinders are in use or connected for use.
8. Read and follow instructions on compressed gas cylinders, associated equipment, and CGA publication P-1 listed in Safety Standards.
9. Near the top of the tank each cylinder has a label, which identifies its contents by name, and a brief symbol, which identifies safety concerns.

It is very important you read and understand all the Material Safety Data Sheets (MSDS) for all substances you work with and around. This is your responsibility!

MOVING PARTS CAN CAUSE INJURY

Moving parts, such as fans, rotors, and belts can cut fingers and hands or catch loose clothing.



1. Keep all doors, panels, covers, and guards closed and secured in place.
2. Have only qualified people remove guards or covers for necessary maintenance and troubleshooting.
3. To prevent accidental starting during servicing, shutdown the entire system, which includes turning off the power supply.
4. Keep hands, hair, loose clothing, and tools away from moving parts.
5. Reinstall panels or guards and close doors when servicing is finished and before starting equipment.

HOT PARTS CAN CAUSE SEVERE BURNS

Avoid any contact with all HOT materials and substances.



1. Allow a cooling period before handling, moving or servicing.
2. Use approved techniques, tools, and safety clothing (gloves, shields, shoes, eye protection, etc.).

STEAM AND PRESSURIZED HOT COOLANT CAN BURN FACE, EYES, AND SKIN

The coolant in the radiators and pressurized hoses is under pressure and can be very hot.



1. Wear gloves and put a rag over cap area when accessing system.
2. Allow pressure to escape before completely opening system.
3. Treat all hoses, hot or cold, with caution. Pressure can cause injury.

ELECTRICAL SHOCK CAN KILL

220 VOLTS

This identification label is used to call attention to immediate or imminent conditions, which if not avoided, will result in serious injury or death. Have only QUALIFIED personnel install, operate, repair, or perform any maintenance on this equipment.

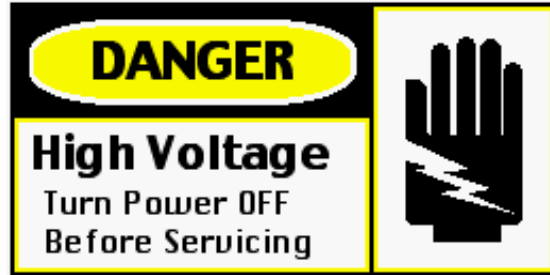

AUTOMATED AND ROBOTIC EQUIPMENT MAY MOVE UNEXPECTEDLY AND CAUSE SERIOUS INJURY OR DEATH AT ANY TIME

Observe all perimeter boundaries for all automated equipment at all times.

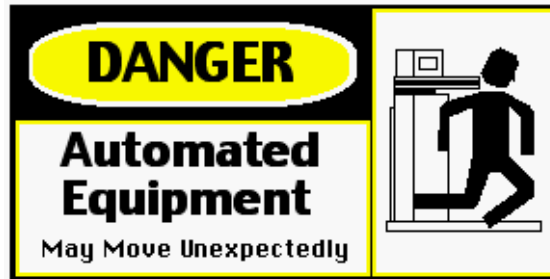

1. Keep all guards, doors, covers, panels, and shields securely attached at all times.
2. Stop entire system when performing any maintenance, repair, installation, or inspections.
3. Observe all Safety Lines and Limits at all times.
4. Wear appropriate safety gear when operating any function of this equipment.
5. If a malfunction occurs:
6. Shut down the entire system.
7. Contact the system manager immediately.
8. If the standard system motion becomes obstructed, DO NOT ATTEMPT to clear the obstruction yourself. Follow procedures described in #5.
9. Shortcuts can cause serious injury or death and may damage the system.
10. In all situations **THINK** before you act.

Principal Safety Standards

- ✚ Safety in Welding and Cutting, ANSI Standard Z49.1, from American Welding Society, 550 N.W. LeJeune Rd, Miami FL 33126
- ✚ Safety and Health Standards, OSHA 29 CFR 1910, from Superintendent of Documents, U.S. Government Printing Office, Washington, D.C. 20402
- ✚ Recommended Safe Practices for the Preparation for Welding and Cutting of Containers That Have Held Hazardous Substances, American Welding Society Standard AWS F4.1, from American Welding Society, 550 N.W. LeJeune Rd, Miami, FL 33126
- ✚ National Electrical Code, NFPA Standard 70, from National Fire Protection Association, Batterymarch Park, Quincy, MA 02269
- ✚ Safe Handling of Compressed Gases in Cylinders, CGA Pamphlet P-1, from Compressed Gas Association, 1235 Jefferson Davis Highway, Suite 501, Arlington, VA 22202
- ✚ Code for Safety in Welding and Cutting, CSA Standard W117.2, from Canadian Standards Association, Standards Sales, 178 Rexdale Boulevard, Rexdale, Ontario, Canada M9W 1R3
- ✚ Safe Practices For Occupation And Educational Eye And Face Protection, ANSI Standard Z87.1, from American National Standards Institute, 1430 Broadway, New York, NY 10018
- ✚ Cutting And Welding Processes, NFPA Standard 51B, from National Fire Protection Association, Batterymarch, Quincy, MA 02269

3. XMS-OSC Standalone System General Description

The XMS Standalone Systems consist of a Hand Pendant used in conjunction with an XM Module. The XM Modules can be programmed to control a variety of weld parameters controlled using the XM Hand Pendant. The XM Handheld Pendant also allows the operator to override certain programmed parameters. Figure 3-1 shows the basic components of the XMS Oscillation Standalone System and Hand Pendant.

Figure 3-1 – XMS Oscillation Standalone Slide, Module and Hand Pendant



3.1. XMS-OSC Standalone System Features

The standalone mechanical oscillators are designed to move a welding arc back and forth. They accomplish this oscillating motion using a mechanical slide to physically move the welding torch or gun in a weaving motion.

AMET has a distinct advantage over “conventional” mechanical oscillators on the market. AMET uses digital signal processing (DSP) technology to provide the ability to completely program the oscillation parameters. Many companies only allow you to program one parameter, such as oscillation width, while the rest of the parameters have to be set physically on an analog control panel. The AMET oscillator allows your operator to program and recall all oscillation parameters during welding, which reduces the chance of an incorrect parameter being set on the control. In addition, the XMS-OSC also allows the operator the ability to override all of the parameters from the hand pendant.

The XMS-OSC is our “Standalone” version, which can be mounted on an existing system and operated independently via a hand pendant. At any time in the future, the XMS-OSC can be integrated with the XM system control.

The XMS-OSC oscillator can be supplied with different slide configurations based on the needs of the application. AMET’s standard oscillator slides are ball screw, driven by a Servo motor with encoder feedback, to insure accurate and precise oscillation.

3.1.1. Applications

The mechanical weld oscillator is designed to provide precisely controlled weaving motion to the weld bead. This type of oscillation motion is typically required for the following welding applications:

- Overlay and hard surfacing projects
- “Cap” pass on a multi-pass weld
- Small oscillation motion to improve sidewall tie-in on “deep” groove welds
- Fillet welds for fill and sidewall tie-in

3.1.2. General Specifications

Table 3-1 – General Specifications	
Oscillation Stroke:	0 to 2” (50 mm) is standard
Oscillation Speed	0 to 100 IPM (2500 mm/min)
Oscillation Start Delay:	0 to 99.9 seconds
Oscillation Stop Delay:	0 to 99.9 seconds
Home Capability:	all models
Left Dwell Time:	0 to 5 seconds, adjustable
Right Dwell Time:	0 to 5 seconds, adjustable
Center Position:	adjustable at all times
Width Setting:	adjustable during oscillation
Speed Setting:	adjustable during oscillation
Closed-loop:	via encoder feedback
Limit Switches:	Includes Home & Travel extents

3.2. XMS Standalone System Major Components

3.2.1. Emergency Stop (E-Stop)

The **Emergency Stop** button immediately ends the selected program and stops critical functions and all motion of the axis. The system remains inactive until an operator pulls the **Emergency Stop** button and pushes the **ESTP** Soft Control Button to clear the Emergency Stop.





Caution:

CAUTION - As the name implies, the Emergency Stop button should be used to avoid damaging the system or to avoid personal injury. It is not intended, nor is it a good practice for stopping the system during normal operations.

3.2.2. Sequence Buttons

The **Start** Sequence Button initiates the selected program or function. If the XMS Module is setup as a slave module, the **Start** Sequence Button will flash while in the *Start-up* screen indicating that the module is waiting for an external input to start the sequence.



The **Stop** Sequence Button ends the selected program. If the XMS-OSC is setup as a “slave” module and the Arc Sense Mode is set to “Input,” the STOP Sequence Button will not end the program. A loss of the digital input that started the program is required.

3.2.3. Soft Buttons

Each **Soft Button** has a corresponding label on the LCD screen (EDIT, DISABLE, LO SPD, and STATUS on the *Start-up* screen). The function of the button changes depending on the screen display. When an **Emergency Stop** is activated, the DISABLE Soft Button changes to an ESTP Soft Button.



The Hand Pendant also has LEFT/RIGHT Arrow Soft Buttons and UP/DOWN Arrow Soft Buttons to navigate the Split Screen Display and select parameters in the *Edit* screen. In the center of the Arrow Soft Buttons is the ENTER Soft Button, used to confirm selections.

3.2.4. Adjustment Knob

The **Adjustment Knob** changes parameter values on the *Edit* Screen and toggles between settings (i.e., enable/disable). It also changes override values during a process.



3.2.5. Joystick

The **Joystick** gives the user manual control of the oscillation slide motion.

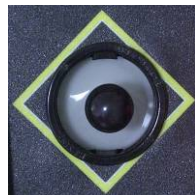

3.2.6. Flash Memory Port

The **Flash Memory Port** accepts Secure Digital memory cards. Firmware from an external source may be loaded to the Hand Pendant. However, programs cannot be saved to the Secure Digital card from the Hand Pendant. The Secure Digital port is adjacent to the E-Stop (see section 3.2.1).

3.2.7. LCD Display

The XMS LCD Display shows different displays depending on which mode or function has been selected. The LCD Display also shows different Soft Button functions depending on which mode or function you have selected.



4. Installation

4.1. Physical Description

The basic XMS-OSC Standalone System consists of a XMS Standalone Hand Pendant, XMS Module and a motion slide assembly. The physical characteristics of the basic system components are shown in Table 4-1, *Physical Characteristics* below:

Table 4-1, Physical Characteristics

System Component	Height	Width	Depth	Weight
XMS Standalone Hand Pendant	6"	4"	2"	2 lbs.
XMS-OSC Module	8"	7"	10-1/2"	10 lbs.
Actuator Assembly	The AMET "standard" slide has a 7.25 inches (180 mm) stroke with a weight capacity of 30 lbs (13.5 kgs) out 6 inches (150 mm) . This is a sealed slide, which is excellent for all arc welding applications. We can provide this slide in strokes from 1.5 to 19.0 inches (30 to 480 mm). If you need to go heavy-duty, AMET can meet this demand as well. We can supply a slide with strokes of 11.8 inches to 59 inches (300 to 1500 mm) with a weight capacity of 135 lbs (60 kgs), out 6 inches (150 mm). AMET can also supply an extra heavy-duty slide if required.			

4.2. Power Requirements

Prior to energizing and operating the XMS-OSC Standalone System check that all electrical cables and hoses are properly connected and tightened. Connection point labels are provided to assure correct installation.

The electrical service requirements for the XMS-OSC Standalone System are listed in Table 4-2, *Electrical Service Requirements* below. The XMS-OSC Standalone Hand Pendant is powered from the XMS-OSC control module.

Table 4-2 – Electrical Service Requirements

Electrical Service	Requirement
Input Voltage	120/240 VAC, 50/60 Hz
Input Current	5 A
Power Consumption	575 W

4.3. Environmental Considerations

Locate the XMS-OSC near a properly rated power source. The use of a power source with a separate power disconnect is recommended. XMS-OSC equipment is designed to operate in a dry, indoor environment. Do not place the XMS-OSC components outside or in an area where water leakage is frequent.

Locate the XMS-OSC Module housing in an unobstructed location to allow for proper air flow through the XMS-OSC Module enclosure. Ensure the front of the XMS-OSC Module enclosure has unrestricted access equal to the depth of the module enclosure, as

access to the internals of the XMS-OSC Module is accomplished by sliding the Module out the front of the enclosure.

Avoid installations where the XMS-OSC is subject to temperature extremes. The XMS-OSC should be operated at temperatures between 40° F and 120° F. Installations in dusty environments or areas of high vibration should be avoided to assure the full operational life of the XMS-OSC.

The XMS-OSC utilizes sensitive and sophisticated microprocessor technology. Avoid the use of hand held radio transmitters in close proximity of the XMS-OSC Hand Pendant Display or Module housing.

4.4. Connections

1. Install the **Terminator** in the IN or OUT Ethernet port on the **XMS-OSC Module**.
2. Connect the XMS-OSC **Hand Pendant** cable to the **XMS-OSC Module**.
3. Connect the **Control Cable** between the **XMS-OSC Module** and the XMS-OSC motion slide.
4. Connect the XMS-OSC Module **Power Cord** to an appropriate power source.
5. Place the **On/Off** switch (located above the power cord input) to the **On** position.

Figure 4-1 - XMS-OSC Connections Diagram

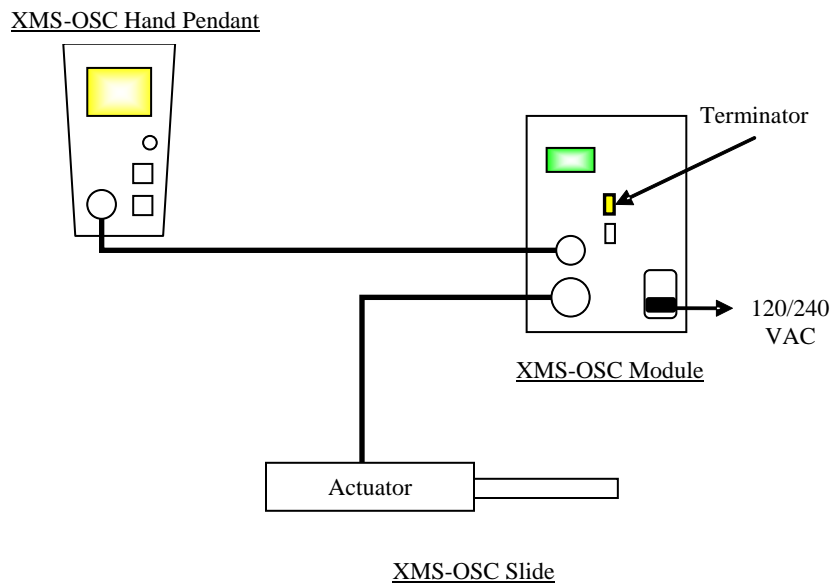

5. Operation

5.1. Initial Setup

Check to be sure the XMS-OSC Standalone System electrical and hose connections (and any connected peripheral equipment) are proper and tight. Ensure the XMS Oscillation Module is connected to an adequate electrical source (refer to Table 4-2). Turn on the XMS-OSC Standalone System at the power switch on the XMS Oscillation Module adjacent to the power cord connector.

Upon startup, the XMS-OSC Hand Pendant display will briefly show the unit's serial number (lower left) and the firmware version loaded on the pendant (lower right). The display will then switch to the normal operating display.

5.2. STARTUP Mode

The Start-Up Mode is the default mode and is displayed on power up of the system. This mode is selected to execute a program. Figure 5-1 shows the XMS Oscillation Standalone Hand Pendant display in STARTUP Mode. The top line of the display shows the currently loaded program number (P01 through P10), the program status (STOPPED), and the module type (XOSC).

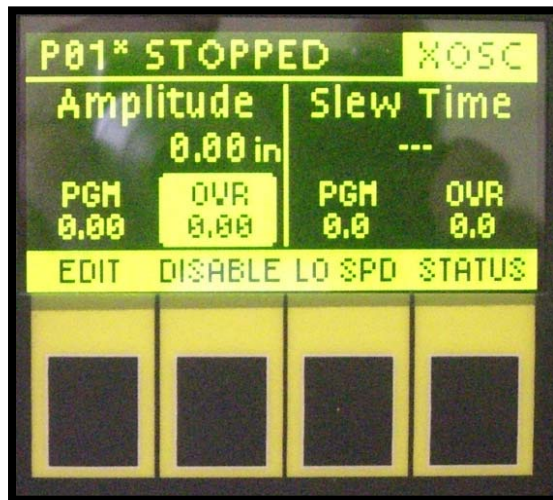

Figure 5-1 – XMS-OSC Hand Pendant *Startup* Screen

The next section of the XMS-OSC Standalone Hand Pendant display is a split screen showing the Amplitude on the left and the Slew Time on the right, along with their programmed values and override values. The bottom line of the display shows the Soft Button labels for EDIT, DISABLE (disables the axis during a program), LO SPD (low speed jog), and STATUS (shows module status).

To override either programmed value use the LEFT/RIGHT Arrow Buttons to highlight the desired parameter and the Adjustment Knob to change the value. Override values can be positive or negative, increasing or decreasing the programmed setting.

5.2.1. Downloading Firmware

The XMS Standalone Pendant can be used to control a variety of XM Firmware Programmable Modules. The firmware is loaded onto the XMS Pendant using the Secure Digital (SD) Flash Card slot.

Insert the SD Flash Card with the desired firmware into the SD Flash Card slot. From the *Start-up* screen, press the EDIT Soft Button then the SETUP Soft Button. Use the UP/DOWN Arrow Soft Buttons to select Download Firmware on the *Setup* screen menu. Press the ENTER soft Button. The display will list the firmware available for downloading. Use the UP/DOWN Arrow Soft Buttons to select the desired firmware and press the ENTER Soft Button to begin the download. The display will show the status of the download and display “done” when the download is complete. When the download has completed press the RESET Soft Button to reset the XMS Standalone Hand Pendant and XMS Module.

5.2.2. How to Load a Program

From the *Start-up* screen, press the EDIT Soft Button, then, press the LOAD Soft Button. Use the LEFT/RIGHT Arrow Buttons to select the desired program (P01 to P10). Press the LOAD Soft Button again to load the program.

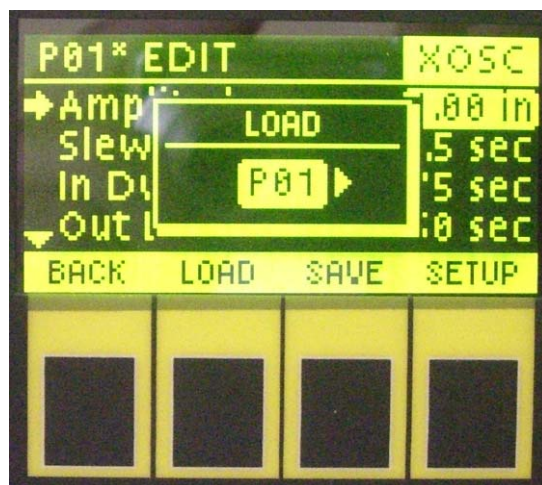

Figure 5-2 – XMS-OSC Hand Pendant *Load* Screen

5.2.3. How to Start a Program

Once the desired program has been loaded and the work piece is ready for the welding operation to begin, press the **Start** Sequence Button. The program status is displayed on the top line of the XMS-OSC Standalone Hand Pendant display.

5.2.4. Error Messages

When the XMS-OSC system encounters an error, a message window pops up in the center of the display describing the error. To acknowledge the message press the ENTER Soft Button.

5.2.5. How to Stop a Program

A weld program can be stopped at anytime by pressing the **Stop** Sequence Button on the XMS-OSC Standalone Hand Pendant. The weld program will be halted at the point the **Stop** Sequence Button is pressed. Pressing the **Start** Sequence Button will restart the weld program from the beginning.

5.3. SETUP Mode

To enter SETUP Mode from the *Start-Up* Screen press the EDIT Soft Button and then press the SETUP Soft Button.

Parameters in the SETUP Mode establish system settings for all programs. Some options include factory set calibrations that **SHOULD NOT** be changed unless specifically instructed to do so by AMET Technical Support personnel.

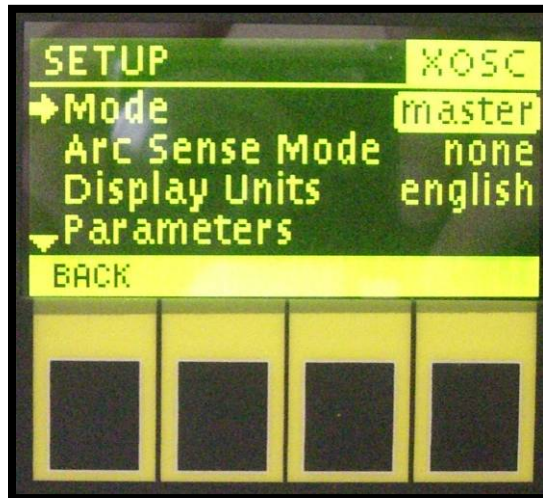

Figure 5-3 – XMS-OSC Hand Pendant *Setup* Screen

The *Setup* screen display is shown in Figure 5-3. The top line of the *Setup* screen displays the programming mode (SETUP) and module type (XOSC). The Setup screen menu options include module Mode (set to master), Arc Sense Mode (none), Display Units (English), Parameters, Servo Cntl, Servo Cal, Joystick, Digital In, Digital Out, and Download Firmware. Below is a table describing the SETUP Mode options and their corresponding parameters and values.

All XMS-OSC Standalone systems are calibrated at the factory prior to shipment. AMET strongly recommends that access to the SETUP Mode be limited to only those individuals with the proper technical qualifications and training. Serious performance problems can jeopardize the quality of the weld process and axis control motor life can be drastically affected if erroneous settings are employed. Please call the AMET Inc. Technical Support hotline at 208-356-7274 for assistance if you are experiencing difficulty with any of the functions of your unit.

Table 5-1 – SETUP Mode Options

Setup Option	Parameter/Value
Mode	<p>Master – With multiple Stand Alone systems connected you must choose one to be the Master. The system and Hand Pedant set to Master executes the weld program. If only one Stand Alone system is present and you want it to start the program sequence by pressing the Start button then you must set the mode to Master.</p> <p>Slave – With multiple Stand Alone systems connected you must set all modules except for one to Slave. If you set the module to Slave mode it will wait for an input to start its program.</p>
Arc Sense Mode	<p>None – Module ignores input for program initiation.</p> <p>Input – Module waits for input for program initiation.</p>
Display Units	<p>English – English units of measure</p> <p>Metric – Metric unit of measure</p>
Parameters DO NOT CHANGE	Amplitude
	Slew Time
	In Dwell
	Out Dwell
	Velocity
	Position
<p>Minimum – Sets the minimum value of the parameter.</p> <p>Maximum – Sets the maximum value of the parameter.</p> <p>Default – Sets the default value of the parameter.</p> <p>Increment – Sets the incremental value of the above parameter attributes from 0.000001 to 1,000,000.</p>	
Servo Cntl DO NOT CHANGE	<p>Servo Control - Adjusts Coarse and Fine settings for Gain and Offset parameters. Also sets minimum and maximum values.</p> <p>Coarse gain – 0 to 255</p> <p>Fine gain – 0 to 255</p> <p>Coarse offset – 0 to 255</p> <p>Fine offset – 0 to 255</p> <p>Min – -999.9 to +999.9</p> <p>Max – -999.9 to +999.9</p>
Servo Cal DO NOT CHANGE	<p>Servo Calibration - These settings change pre-set Servo calibration parameters.</p> <p>K_p – Proportional Gain</p> <p>K_d – Derivative Gain</p> <p>K_i – Integral Gain</p> <p>K_i Limit –Integral Gain Limit</p> <p>Bias – Bias output either side of zero</p> <p>Friction -</p> <p>Counts/Unit – Number of encoder counts per unit of measure</p> <p>Default Velocity – Used for home sequence and program default</p> <p>Default Acceleration – Used for home sequence and program default</p> <p>Direction – Selects which direction is positive or negative</p> <p>Limit direction – Phases the limits with the axis direction</p> <p>Home direction – Selects the direction of the home axis</p>
Joystick	<p>Up action – jog neg, jog pos, none, output 1 thru 8</p> <p>Down action – jog neg, jog pos, none, output 1 thru 8</p> <p>Right action – jog neg, jog pos, none, output 1 thru 8</p> <p>Left action – jog neg, jog pos, none, output 1 thru 8</p>

Table 5-1 – SETUP Mode Options	
Setup Option	Parameter/Value
	Jog high speed – adjusts the velocity of the high speed jog Jog low speed – adjusts the velocity of the low speed jog
Digital In	Digital In – Displays digital status information from an external source.
Digital Out	Digital Out – Adjusts the status of digital outputs (1 thru 8) to an external source. This option can be used to manually toggle the digital output for troubleshooting or testing.
Download Firmware	Download Firmware – Allows the user to download firmware to the Hand Pendant or to the XM Module to which it is connected.

5.4. EDIT Mode

To enter the EDIT Mode from the *Startup* Screen, press the EDIT Soft Button. The parameters available in the EDIT Mode are used to build a program sequence. These parameters set how the program will run, how it will end, and all associated values related to this sequence.

The *Edit* screen shows the loaded program (P01 to P10), the program status (EDIT) and the XM Module (XOSC) type on the top line of the display. The middle of the display shows the parameters that can be edited, including: Amplitude, Slew Time, In Dwell, Out Dwell, End Time, Start Delay, Early Stop, Stop Delay, Pre Purge, and Post Purge.

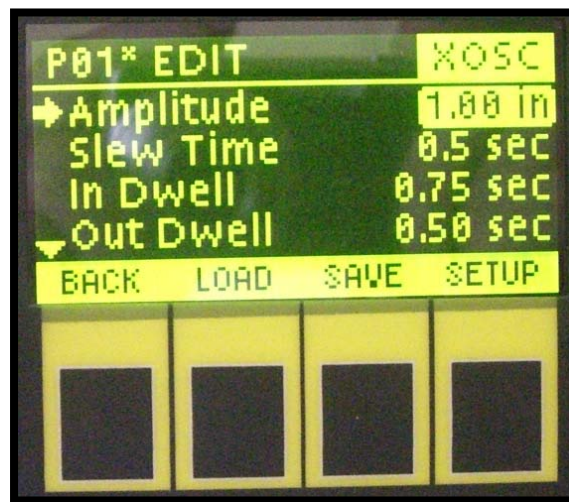

Figure 5-4 – XMS-OSC Hand Pendant *Edit* Screen

To select a parameter for editing, use the UP/DOWN Arrow Buttons to highlight the parameter and the Adjusting Knob to change the value to the desired setting. Table 5-2, *EDIT Mode Options*, describes the EDIT Mode parameters, their corresponding descriptions and range of settings available.

Table 5-2 – EDIT Mode Options

Parameter	Description	Range/Settings
Amplitude	Defines the oscillation width (in inches) for the segment.	0.0 to 1.00 inches 0.0 to 1.00 cm
Slew Time	Sets the time (in seconds) to travel from dwell to dwell.	0.0 to 100.0 seconds
In Dwell	Sets the time (in seconds) spent on either extreme side from the center, respectively.	0.00 to 10.00 seconds
Out Dwell		
End Time	Sets the end of the weld segment to either MANUAL or a specific time (in seconds). When set to MANUAL this option deactivates the EARLY STOP option and requires the operator to press the STOP button to stop the program.	Manual 0.1 to 999.0 seconds
Start Delay	Sets the time (in seconds) from the beginning of the segment until the programmed linear motion begins.	0.0 to 100.0 seconds
Early Stop	Sets the amount of time (in seconds) before the program ends, at which time the linear motion stops. NOTE: When active, this option deactivates Stop Delay when set to greater than 0.0 seconds.	0.0 to 100.0 seconds
Stop Delay	NOTE: This option is NOT active when Early Stop is set to greater than 0.0 seconds. Sets the amount of time (in seconds) linear axis motion continues after the weld stops.	0.0 to 999.0 seconds
Pre Purge	Sets the time in seconds for the purge gas to run prior to the beginning of the program.	0.0 to 999.0 seconds
Post Purge	Sets the time in seconds for the purge gas to run after the program stops.	0.0 to 999.0 seconds

5.4.1. How to Load a Program

From the *Start-up* screen, the four (4) Soft Buttons below the Split Screen Display read EDIT, DISABLE, LO SPD, and STATUS. Press the EDIT Button, then, press the LOAD Button. Use the LEFT/RIGHT Soft buttons to select the desired program (P01 to P10). Press the LOAD Button again to load the program. (See Figure 5-2, *XMS-OSC Hand Pendant Load Screen*.)

5.4.2. How to Create a Weld Program

A weld program is created by editing the weld parameters in the SETUP Mode and EDIT Mode to the desired values. The new settings are then saved to the current or other program number. The XMS-OSC Standalone Hand Pendant can save or load up to ten different weld programs.

5.4.3. How to Save a Weld Program

After entering desired program settings, save the program from the *Edit* screen. Press the SAVE Soft Button. Select the desired program number (P01 to P10) by pressing the LEFT/RIGHT Arrow Buttons and press the SAVE Soft Button again. The XMS Standalone Oscillation Hand Pendant can save up to 10 programs.

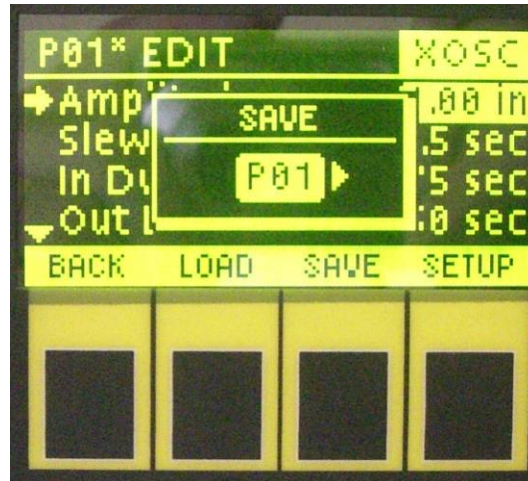

Figure 5-5 – XMS-OSC Hand Pendant *Save* Screen

5.5. Power Down and Securing the Equipment

Ensure any hot work has been removed from the system, or is safe to leave “as is” and no safety hazards exist. Press the **Stop** Sequence Button. Check to ensure any connected peripherals or assemblies are properly shutdown and secured. Remove power from the XMS-OSC Standalone System by turning the power switch to OFF.

If the system will be left for any appreciable time, provide protection from dust or other environmental impacts appropriately, such as by using a dust cover after ensuring the system is cool. Ensure any cover (or other) gasses, cooling water and pneumatic sources are isolated from the system.

6. General Maintenance

Although the XMS-OSC Standalone System components are designed for typical industrial environments and use, some inspection and maintenance is suggested to insure reliable use and long life. Table 6-1, *Maintenance Recommendations* should be used as a guide, although each system, facility, and installation may be unique and users and maintenance procedures should be adjusted for local needs and requirements.

Table 6-1 – Maintenance Recommendations

Frequency	Task	Comment
Pre-Operation & Each Operation	Connections	Visually check that all electrical connections and hoses are tight and that wear or damage is not evident.
	Cooling/Air Filtration	Insure that the air intake and exhaust on the sides of the Control Enclosure are not blocked.
	Connections	Inspect and tighten all connections and hoses. Inspect are tight and that wear or damage is not evident
	Hand Pendant	With a clean soft cloth and a mild liquid detergent, wipe the display clean. NOTE: Abrasives and acid/solvent or harsh cleaning agents may damage the display overlay. Use care in cleaning that area.
Weekly	Calibration	Visually check that all electrical connections and hoses are tight and that wear or damage is not evident.
		Perform a calibration check to verify that the XMS Oscillation slide is being positioned properly. Calibration procedures are available from AMET Technical Support (208) 356-7274 and on http://www.ametinc.com/literature.html .
Monthly	Connections	Check the tightness of all mechanical connections on the XMS Oscillation Slide.

7. Troubleshooting

This troubleshooting guide is intended to provide *general* assistance for common problems. For assistance with a specific XMS Standalone System failure or to request information on a technical issue with the XMS Standalone System, please contact AMET Technical Support hotline at 208-356-7274.

Table 7-1 – Troubleshooting Guide

Trouble or Problem	Suggested Resolution
The XMS Standalone Hand Pendant System does not turn on when the power switch on the Controller Enclosure is turned to ON.	<p>Check that the XMS System is connected to an adequate power source and power is available.</p> <p>Check that the 115/220 Volt selector is positioned to the correct input voltage.</p> <p>After removing the power cord, check the fuse in the XM Module and replace if necessary.</p>
Cannot clear E-Stop	<p>Check to make sure that the E-Stop Button has been pulled out.</p> <p>Make sure that you press the “ESTP” Soft Button once you have pulled out the E-Stop Button.</p> <p>Make sure that the terminator is installed in one of the Ethernet ports on the front of the XMS Oscillation Module.</p>
“START” Button will not activate a program	Check the settings in the “Setup” Mode to make sure that the “Mode” and the “Arc Sense Mode” are set properly (See section 5.3).
Hand Pendant Displays “Following Error”	<p>Check to make sure that the motor cable is plugged into the XMS Oscillation Slider.</p> <p>Check to make sure that E-Stop has been cleared</p>